

STOKPLAS - DEDICATED TO QUALITY

Stokplas is a leading distributor of industrial thermoplastic pipework systems. Our excellent reputation has been earned through the supply of first class materials to industry, backed by personal service and expertise.

Expertise in Plastics

Our staff can provide independent advice on all of our products and their applications, providing proven solutions backed with full Manufacturer's support and warranty. With the skilled project management team, customers have the assurance of meeting tight deadlines or delivery requirements, liaising with others involved in the project and receiving what they need, when they need it.

Stokplas knowledge, stockholding and service set the standard

The range of Stokplas products for the manufacturing and process industries is not just limited to those contained in this Price Guide. Stokplas is part of the Crossling Group of Companies who are one of the UK's leading independent plumbing and pipeline merchants. This enables Stokplas to also provide your requirements for steel, brass or copper fittings, valves and ancillary pipeline equipment and tools for all trades. You can have them in the same delivery, on the same advice note and invoice. What could be simpler? You can also use your Stokplas account to purchase from any Crossling Branch or from Northern Tools & Accessories.



With instant availability from extensive stocks, we provide fast, efficient delivery. We have the belief that all our customers are of equally high importance to us, each with their own unique requirements and we endeavour to not only meet, but also exceed your expectations.

We aim to provide an excellent service to you and your company, maintaining a prompt and thoughtful attitude. We ensure a high level of technical support, with continuous staff training, so that we can help you to make the correct and cost effective buying decisions. Our service is further enhanced with the technical support of our manufacturing partners. We can provide you with help and advice throughout all stages of a project, from design to commissioning; and we can back this up with site visits. Stokplas are recognised industry specialists and are A1 distributors of George Fischer products.

Quality Assurance

We understand the importance that many companies attach to quality. For this reason we operate a strict quality system approved to BS EN ISO 9001:2000.



Mission Statement

Our aim is to excel as a supplier to a wide customer base made up of organisations from commercial and industrial sectors and local authorities. To be the market leaders in reliability, quality and efficiency through continued commitment to product quality, stock holding, customer service and employee development.

Opening Hours

We're just a phone call away, telephone 01302 342121 8am to 5pm Monday to Friday or fax your enquiries to 01302 556950 or e-mail: stokplas@crossling.co.uk.

Purchasing

We have no minimum order size. If you don't have an account, please call us for an application form. We accept credit cards, including Visa and MasterCard; or corporate purchase cards, debit cards, cheques or cash. Please call 01302 342121.

Training

Stokplas provides training for installation and jointing techniques, on-site or in-house and at our suppliers' premises.



Distribution

We provide distribution using our own transport; we can be flexible enough to cater for all deliveries, large or small and we offer a next day carrier service for those really urgent requirements.

INDEX

INDUSTRIAL

ABS - Acrylonitrile Butadiene Styrene

Introduction	3
ABS Pipe	3
ABS Imperial Fittings	3-5
ABS Flanges	5
ABS Solvent Cement & Cleaning Fluid	5
ABS Ball Valves	6
ABS Ball Check Valves	6
ABS Butterfly Valves	6
ABS Pressure Release Valves	7
ABS Diaphragm Valves	7
ABS Sediment Strainers	7
ABS Flow Meters	7

PVC-U - Unplasticised Polyvinyl Chloride

Introduction & cements	8
PVC-U Imperial Pipes	8
PVC-U Imperial Fittings	8-10
PVC-U Imperial Flanges	9-10
Metric Pipe	10
Metric Fittings	10-12
PVC-U Metric Flanges	12
PVC-U Solvent Cements & Cleaners	12
PVC-U Ball Valves	13-14
PVC-U Diaphragm Valves	15
PVC-U Butterfly Valves	15
PVC-U Air Release Valves	15
PVC-U Ball Check Valves	15-16
PVC-U Angle Seat Valves	15-16
PVC-U Screen Assembly	15
PVC-U Sediment Strainers	16-17
PVC-U Butterfly Valves	17
PVC-U Pressure Relief Valves	17
PVC-U Flow Meters	18

PVC-C - Post Chlorinated PVC

Introduction, PVC-C Cements & Cleaning Fluid	19
PVC-C Metric Pipe	19
PVC-C Metric Fittings	19-20
PVC-C Jointing Procedure	20
PVC-C Corzan Ball Valves	21
PVC-C Ball Valves	21
PVC-C Ball Check Valves	22
PVC-C Diaphragm Valves	22
PVC-C Sediment Strainers	22

PP - Polypropylene

Introduction	27
PP Pipe	27
PP Socket Fusion Fittings	27
PP Valves	27

PVDF - Polyvinyl Fluoride

Introduction	28
PVDF Pipe	28
PVDF Fittings	28
PVDF Valves	28
PVDF Jointing Technology	28

WATER SERVICES

INSTAFLEX

Introduction	29
Instaflex Pipe	29
Instaflex Fittings	29
Instaflex Electro Fusion Fittings	29
Instaflex PB Valves	29

FRIATHERM

Introduction	30
Friatherm Pipe	30
Friatherm Fittings	30
Friatherm Consumables	30

FRIAPHON

Introduction	31
Friaphon Pipe	31
Friaphon Fittings	31
Friaphon Consumables	31

VULCATHENE

Introduction	32
Vulcathene Mechanical Fittings	32
Vulcathene Enfuson Fittings	33

COOLFIT

Introduction	34
Coolfit Pipe	34
Coolfit Fittings	34

INFORMATION SECTIONS

Actuation	23
Valve Quotation Request Form	24
Measurement and Control	25
Flange Tables	48
Material Selection Information	49
Material Data Grid	50

BUILDING SERVICES

PUMPS

Introduction	35
DAB	35
Crosco Pump Bellows	35

SECONDARY CONTAINMENT

Introduction	26
Contain-it & Contain-it Plus	26

PLASSON

Introduction	38
Electrofusion Fittings	38-41
Mechanical Fittings	42-44
Plasson Mechanical Valves	44
Plasson Mechanical Accessories	44

KEE KLAMP

Introduction	45
Kee Klamp Structural Fittings	45-46
Kee Klamp 500 Series	46

PIPE HANGING

Pipe Hanging Fittings	47
Klip-it Fittings	47
Pipedamp	47
Pipe Fittings	47
Cobra Clips	47
Saddle Clips	47

STAINLESS STEEL

Stainless Tube, Pipe Fittings & Valves	36
--	----

PLEASE NOTE:
Whilst every care has been taken to ensure that the descriptions and prices quoted in this Price Guide are accurate we cannot be held responsible for any errors or omissions. Items are invoiced at the price ruling at the date of despatch unless otherwise agreed.

FLOW CONTROL SOLUTIONS

Trusted worldwide for quality of manufacture GF products are simple to operate and provide multiple solutions for virtually all fluid processing requirements.

We are dedicated to designing, manufacturing and marketing piping systems for the safe and secure conveyance of liquids and gases. GF also provides innovative solutions for connection systems and flow control.

www.georgefisher.co.uk

+GF+

George Fisher Sales Limited,
Paradise Way, Coventry CV3 2ET
Telephone: 024 7655 0538
Fax: 024 7655 8488
email: gf@georgefisher.com

Durapipe UK Industrial Pipework Systems

- Durapipe abs** Low temperature water transportation
- Durapipe pvc-u** Process chemicals & industrial fluid handling
- Durapipe corzan** C-pvc system for hot corrosive fluids
- Vulcathene** Safe chemical drainage
- friatherm** Hot and cold pipework system. Quick and easy installations of hot and cold water pipework.
- friaphon** Sound attenuated drainage. Sound attenuated drainage system with no need for lagging.

Call us on 01543 279909
enquiries@durapipe.co.uk
or visit the website www.durapipe.co.uk

an Ollaxiss company

INDEX



Plasson ElectroFusion Fittings - The Smart-System Solution You Can Depend On

Plasson ElectroFusion fittings are specifically designed for reliable, high performance pipe joining and long system life. This automated system has been proven to be most economical due to the low potential for operator error

All Plasson products combine to form the latest state-of-the-art high performance pipe joining solution. Plasson ElectroFusion fittings are part of a complete electrofusion smart system. The entire ElectroFusion process is executed and fully monitored by the computerised control box. Everything is computer-controlled ensuring safe, dependable connections. Plasson ElectroFusion fittings can be used with Plasson's computerised smart-system control box or with standard barcode systems. Each Plasson ElectroFusion fitting comes complete with a barcode.

Advantages

- Stronger pipe joining - Plasson ElectroFusion quality fittings have long penetration depths and fusion zones which ensure high quality joints.
- Most Economical - Economic benefits are a result of overall integrated n system quality and innovation including the computerised smart system which reduces the potential for operator error.
- High Performance - Proven high performance in gas and water distribution and industrial applications.
- Superior Service - Plasson provides unmatched service based on over 40 years in the field

PLASSON ELECTROFUSION FITTINGS

Coupler 49010:		
20		6.03
25		6.03
32		6.03
40		9.03
50		9.29
63		11.17
75		17.15
90		17.30
110		26.52
125		30.39
140		38.98
160		47.52
180		56.07
200		79.56
225		90.22
250		129.99
280		196.98
315		217.98
355		398.50
400		435.75
Lightfit Coupler 36010:		
63		10.40
75		15.76
90		17.01
110		21.80
125		27.22
140		29.30
160		32.00
180		44.86
200		57.96
225		74.34
250		102.32
280		150.19
315		170.86
355		241.92
400		333.59
Long Coupler 49011:		
32		8.83
40		10.66
50		13.40
63		15.83
Monolithic End Cap 49420:		
32		13.34
40		16.34
50		20.14
63		-

PLASSON ELECTROFUSION FITTINGS





End Cap 49120:		
20		10.71
25		11.48
32		12.55
40		14.60
50		21.35
63		24.15
75		44.10
90		49.72
110		71.43
125		80.19
140		91.68
160		120.83
180		157.82
200		191.89
225		202.11
250		208.95
280		460.95
315		599.55
Reducing Coupler 49110		
20 x 16		6.06
25 x 20		6.06
32 x 20		6.06
32 x 25		6.06
40 x 25		12.42
40 x 32		12.42
50 x 25		17.90
50 x 32		17.90
50 x 40		19.22
63 x 32		15.50
63 x 40		15.50
63 x 50		17.86
75 x 63		20.34
90 x 50		22.97
90 x 63		22.97
90 x 75		22.97
110 x 63		32.31
110 x 90		32.31
125 x 90		46.13
125 x 110		50.40
160 x 90		77.70
160 x 110		77.70
160 x 125		77.70
180 x 125		85.10
Spigot Reducer 49117:		
50x40		9.74
50x32		9.82
63x32		13.43
63x40		13.43
63x50		13.43
75x63		20.70
90x50		20.70
90x63		28.27
90x75		28.27
110x63		37.72
110x75		37.72
110x90		37.72
125x63		45.58
125x90		45.58
125x110		45.58
140x90		65.63
140x110		65.63
140x125		65.63
160x90		87.60
160x110		87.80
160x125		87.80
160x140		87.80
180x90		98.05
180x125		98.05
180x140		106.61
180x160		106.61
200x140		124.10
200x160		124.10
200x180		124.10

PLASSON ELECTROFUSION FITTINGS



Reducing Tee 49140:		
25x20x25		16.95
25x32x25		16.95
32x20x32		16.95
32x25x32		16.95
40x20x40		20.48
40x25x40		20.48
40x32x40		20.48
50x20x50		27.07
50x25x50		27.07
50x32x50		27.07
50x40x50		27.07
63x20x63		38.61
63x32x63		38.61
63x40x63		38.61
63x50x63		38.61
75x63x75		56.70
90x63x90		72.41
110x63x110		158.60
110x90x110		122.35
125x90x125		139.18
125x110x125		149.63
160x90x160		219.45
160x110x160		219.45
160x125x160		219.45
180x90x180		301.35
180x110x180		301.35
180x125x180		301.35
180x140x180		301.35
180x160x180		301.35
200x90x200		383.25
200x110x200		383.25
225x90x225		432.60
225x110x225		432.60
250x90x250		572.25
250x110x250		572.25
Tee 49040:		
20x20x20		13.23
25x25x25		13.09
32x32x32		14.08
40x40x40		21.82
50x50x50		26.62
63x63x63		29.91
75x75x75		45.01
90x90x90		51.61
110x110x110		77.18
125x125x125		99.26
160x160x160		163.85
200x200x200		340.86
225x225x225		387.34
250x250x250		521.78
Flanged Tee 49940:		
90x80x90		134.62
110x80x110		160.15
110x100x110		182.57
125x80x125		167.56
125x100x125		174.64
160x80x160		266.72
160x100x160		281.80
180x80x180		341.53
180x100x180		349.93
90° Elbow 49050:		
20		14.08
25		14.08
32		14.08
40		20.11
50		27.62
63		29.43
75		39.90
90		42.00
110		64.05
125		72.45
140		93.56
160		134.40
180		164.85
200		283.19
225		338.25
250		420.46

PLASSON ELECTROFUSION

PLASSON ELECTROFUSION FITTINGS

	Spigot End Plug 49127:		
	20	2.87	
	25	3.08	
	32	3.36	
	40	3.57	
	50	4.76	
	63	7.63	
	75	10.01	
	90	16.71	
	110	22.85	
	125	27.85	
	140	32.64	
	160	44.55	
	180	52.92	
	200	137.55	
	225	151.26	
	250	194.04	
280	245.81		
315	336.93		
	Elbow 45° 49060:		
	32	13.42	
	40	19.06	
	50	22.02	
	63	29.38	
	75	39.82	
	90	43.94	
	110	64.96	
	125	72.89	
	140	93.56	
	160	134.40	
	180	165.55	
200	283.19		
225	338.25		
250	420.46		
	Elbow 22.5° 49020:		
	90	37.80	
	110	48.01	
	125	70.25	
	160	124.11	
	Elbow 180° 49090:		
	25	34.00	
	32	41.00	
	40	51.00	
	Adjustable Elbow 49470:		
	110	146.03	
	125	180.81	
	160	259.81	
	Adj Elbow 1 sided 49471:		
	110 x 110	120.33	
	125 x 125	146.54	
	160 x 160	216.97	
	Duckfoot Elbow 90° with outlet 49650:		
	90x32	109.75	
	Duckfoot Elbow 90°	90	105.02
		Repair Saddle 49520:	63
75	41.12		
90	42.66		
110	46.88		
125	53.99		
140	65.33		
160	70.61		
180	80.96		

PLASSON ELECTROFUSION FITTINGS

	Transition Saddle 49380:	
	63x1.1/4"	57.61
	75x1.1/4"	84.36
	90x1.1/2"	84.36
	90x2"	78.53
	110x1.1/2"	80.73
	110x2"	86.76
	125x1.1/2"	90.66
	125x2"	92.66
	140x1.1/2"	110.31
	140x2"	123.23
	160x1.1/2"	123.23
	160x2"	103.37
	180x1.1/2"	104.19
	180x2"	104.93
	200x2"	113.81
	225x2"	126.91
250x2"	137.05	
	Balloon Saddle 49680:	
	90x2.1/2"	102.50
	110x2.1/2"	110.90
	125x2.1/2"	116.25
	140x2.1/2"	117.50
	160x2.1/2"	118.50
	180x2.1/2"	120.25
	200x2.1/2"	126.14
	225x2.1/2"	133.97
250x2.1/2"	144.55	
	Branch Saddle 49580:	
	63 x 32	52.16
	63 x 40	52.16
	63 x 50	52.16
	63 x 63	52.16
	75 x 32	52.16
	75 x 40	52.16
	75 x 50	52.16
	75 x 63	52.16
	90 x 32	52.16
	90 x 40	52.16
	90 x 50	52.16
	90 x 63	52.16
	90 x 90	75.95
	110 x 32	52.16
	110 x 40	52.16
	110 x 50	52.16
	110 x 63	53.03
	110 x 90	75.95
	125 x 32	52.16
	125 x 40	52.16
	125 x 50	52.16
	125 x 63	52.16
	125 x 90	75.95
	140 x 32	72.64
140 x 40	72.64	
140 x 50	72.64	
140 x 63	72.64	
140 x 90	94.44	
160 x 32	80.96	
160 x 40	80.96	
160 x 50	80.96	
160 x 63	64.10	
160 x 90	159.99	
180 x 32	71.60	
180 x 40	72.36	
180 x 50	72.36	
180 x 63	71.60	
180 x 90	159.09	
200 x 63	77.90	
200 x 90	178.35	
225 x 63	77.90	
225 x 90	178.35	
250 x 63	79.80	
250 x 90	178.35	

PLASSON ELECTROFUSION FITTINGS

	Tapping Saddle & Parallel Outlet Saddle 49630/49530:	
	40 x 20	47.25
	40 x 32	47.25
	50 x 20	47.25
	50 x 25	47.25
	50 x 32	47.25
	63 x 20	47.25
	63 x 25	47.25
	63 x 32	47.25
	63 x 40	75.12
	63 x 50	75.12
	63 x 63	75.12
	75 x 20	66.47
	75 x 32	66.47
	75 x 40	66.47
	75 x 50	66.47
	75 x 63	75.12
	90 x 20	47.25
	90 x 25	75.12
	90 x 32	47.25
	90 x 40	47.25
	90 x 50	75.12
	90 x 63	75.12
	110 x 20	47.25
	110 x 32	47.25
	110 x 40	47.25
	110 x 50	75.12
	110 x 63	75.12
	125 x 20	47.25
	125 x 32	47.25
	125 x 40	47.25
	125 x 50	75.12
125 x 63	75.12	
140 x 20	84.04	
140 x 32	84.04	
140 x 40	84.04	
140 x 50	84.04	
140 x 63	84.04	
160 x 20	56.55	
160 x 32	47.25	
160 x 40	55.71	
160 x 50	75.12	
160 x 63	75.12	
180 x 20	75.12	
180 x 32	65.08	
180 x 40	75.12	
180 x 50	75.12	
180 x 63	75.12	
200 x 20	149.31	
200 x 32	118.49	
200 x 40	149.31	
200 x 50	149.31	
200 x 63	118.49	
225 x 20	118.49	
225 x 32	118.49	
225 x 40	149.31	
225 x 50	149.31	
225 x 63	118.49	
250 x 20	149.31	
250 x 32	118.49	
250 x 40	149.31	
250 x 50	149.31	
250 x 63	149.31	

PLASSON ELECTROFUSION FITTINGS

Tapping Valve 49540:	
63 x 32	203.57
63 x 40	203.57
63 x 50	203.57
63 x 63	203.57
75 x 32	215.46
75 x 40	215.46
75 x 50	215.46
754 x 63	215.46
90 x 32	231.43
90 x 40	231.43
90 x 50	235.54
90 x 63	235.54
110 x 32	244.31
110 x 40	244.31
110 x 50	253.32
110 x 63	253.32
125 x 32	262.46
125 x 40	262.46
125 x 50	271.47
125 x 63	271.47
140 x 32	282.24
140 x 40	282.24
140 x 50	282.24
140 x 63	282.24
160 x 32	294.15
160 x 40	294.15
160 x 50	305.42
160 x 63	305.42
180 x 32	327.25
180 x 40	327.25
180 x 50	327.25
180 x 63	327.25
200 x 32	343.29
200 x 40	343.29
200 x 50	343.29
200 x 63	343.29
225 x 32	358.72
225 x 40	358.72
225 x 50	358.72
225 x 63	358.72
250 x 32	374.22
250 x 40	374.22
250 x 50	374.22
M Trans Coupler 49210:	
20 x 1/2"	27.39
25 x 3/4"	28.25
32 x 1/2"	28.25
32 x 3/4"	28.25
32 x 1"	28.25
32 x 1.1/4"	35.68
32 x 1.1/2"	38.28
40 x 1"	34.06
40 x 1.1/4"	34.06
40 x 1.1/2"	36.09
40 x 2"	48.96
50 x 1"	38.65
50 x 1.1/4"	39.65
50 x 1.1/2"	40.80
50 x 2"	50.96
63 x 1.1/4"	59.23
63 x 1.1/2"	54.66
63 x 2"	56.26
75 x 2"	81.21
F Trans Coupler 49310:	
20 x 1/2"	25.22
25 x 3/4"	29.33
32 x 1"	33.42
32 x 1.1/2"	36.86
40 x 1"	40.70
40 x 1.1/4"	40.70
40 x 1.1/2"	43.09
50 x 1.1/2"	49.53
50 x 2"6	57.25
63 x 1.1/2"	57.00

PLASSON ELECTROFUSION FITTINGS

Weldable Trans F 49317:	
20 x 1/2"	25.85
25 x 3/4"	29.32
32 x 3/4"	34.15
32 x 1"	38.20
32 x 1.1/2"	41.20
40 x 1"	43.88
40 x 1.1/4"	43.88
40 x 1.1/2"	46.88
50 x 1.1/2"	51.85
50 x 2"	59.29
63 x 1.1/2"	63.89
63 x 2"	62.55
Weldable Trans M 49217:	
20 x 1/2"	19.11
25 x 3/4"	22.55
32 x 1/2"	27.72
32 x 3/4"	27.72
32 x 1"	27.72
32 x 1.1/4"	31.98
32 x 1.1/2"	34.77
40 x 1"	35.62
40 x 1.1/4"	34.77
40 x 1.1/2"	37.54
40 x 2"	44.26
50 x 1"	39.84
50 x 1.1/4"	38.13
50 x 1.1/2"	38.13
50 x 2"	44.52
63 x 1.1/4"	52.04
63 x 1.1/2"	50.53
63 x 2"	49.50
75 x 2"	71.18
75 x 2.1/2"	71.18
F Trans Elbow 90° 49350	
20 x 1/2"	24.95
25 x 3/4"	28.29
32 x 3/4"	34.11
32 x 1"	34.11
40 x 1"	38.85
40 x 1.1/4"	39.55
40 x 1.1/2"	44.00
50 x 1.1/2"	50.58
50 x 2"	57.20
63 x 1.1/2"	55.11
63 x 2"	57.31
F Trans Elbow 45° 49360	
32 x 1"	34.02
40 x 1"	35.91
40 x 1.1/4"	35.91
40 x 1.1/2"	42.34
50 x 1.1/2"	54.37
50 x 2"	50.56
63 x 1.1/2"	57.86
63 x 2"	58.85
M Trans Elbow 45° 49260	
32 x 1/2"	33.26
32 x 3/4"	33.26
32 x 1"	32.76
32 x 1.1/4"	37.23
32 x 1.1/2"	39.94
40 x 1"	43.26
40 x 1.1/4"	43.26
40 x 1.1/2"	44.28
40 x 2"	51.09
50 x 1"	47.99
50 x 1.1/4"	47.99
50 x 1.1/2"	49.78
50 x 2"	53.17
63 x 1.1/4"	61.80
63 x 1.1/2"	54.66
63 x 2"	55.06
75 x 2"	84.74
75 x 2.1/2"	84.74

PLASSON ELECTROFUSION FITTINGS

M Trans Elbow 90° 49250:	
20 x 1/2"	28.35
25 x 3/4"	27.05
32 x 1/2"	34.37
32 x 3/4"	34.37
32 x 1"	34.37
32x 1.1/4"	37.23
32 x 1.1/2"	39.94
40 x 1"	38.85
40 x 1.1/4"	39.55
40 x 1.1/2"	44.00
40 x 2"	51.09
50 x 1"	48.48
50 x 1.1/4"	50.58
50 x 1.1/2"	50.58
50 x 2"	53.17
63 x 1.1/4"	53.17
63 x 1.1/2"	55.11
63 x 2"	57.31
75 x 2"	84.74
75 x 2.1/2"	84.74
F Trans Elbow 45° 49360:	
32 x 1"	34.02
40 x 1"	35.91
40 x 1.1/4"	35.91
40 x 1.1/2"	42.34
50 x 1.1/2"	54.37
50 x 2"	50.56
63 x 1.1/2"	57.86
63 x 2"	58.85
M Free Nut Trans Coupler 49411:	
32 x 1"	53.34
40 x 1.1/4"	66.87
50 x 1.1/2"	76.68
63 x 1.1/2"	95.01
63 x 2"	95.01
F Free Nut Trans Coupler 49410:	
20 x 3/4"	31.67
25 x 3/4"	35.93
25 x 1"	42.27
32 x 1"	42.27
32 x 1.1/4"	47.34
40 x 1.1/2"	53.48
50 x 2"	67.54
63 x 2"	74.48
63 x 2.1/2"	75.75
M Free Nut Trans Elbow 90° 49451:	
32 x 1"	53.34
40 x 1.1/4"	73.54
50 x 1.1/2"	76.68
63 x 1.1/2"	95.08
63 x 2"	95.08
F Free Nut Trans Elbow 90° 49450:	
20 x 3/4"	31.67
25 x 3/4"	35.94
25 x 1"	42.27
32 x 1"	42.27
32 x 1.1/4"	47.33
40 x 1.1/2"	53.48
50 x 2"	67.55
63 x 2"	74.48
63 x 2.1/2"	75.81

PLASSON ELECTROFUSION

PLASSON ELECTROFUSION FITTINGS

	M Free Nut Trans Elbow 45° 49461:	
	32 x 1"	53.34
	40 x 1.1/4"	73.54
	50 x 1.1/2"	76.68
	63 x 1.1/2"	95.08
	63 x 2"	95.08
	F Free Nut Trans Elbow 45° 49460:	
	32 x 1"	42.27
	32 x 1.1/4"	47.33
	40 x 1.1/2"	53.48
	50 x 2"	67.55
	63 x 2"	74.48
	63 x 2.1/2"	75.81
	F Union Free Nut Trans Tee 49450:	
	32 x 1"	191.75
	PE Male Trans Coupler 49710:	
	20 x 1/2"	12.60
	25 x 3/4"	15.94
	32 x 1"	17.26
	40 x 1"	21.23
	40 x 1.1/4"	21.23
	40 x 1.1/2"	28.92
	50 x 1.1/2"	33.33
	63 x 1.1/2"	33.39
	63 x 2"	
	PE Male Trans Elbow 90° 49750:	
	20 x 1/2"	19.75
	25 x 3/4"	20.35
	32 x 1"	21.04
	40 x 1"	26.65
	40 x 1.1/4"	26.65
	40 x 1.1/2"	26.65
	50 x 1.1/2"	27.78
	63 x 1.1/2"	36.29
63 x 2"	36.29	
	PE Male Trans Elbow 45° 49760:	
	32 x 1"	21.04
	40 x 1"	26.65
	40 x 1.1/4"	26.65
	40 x 1.1/2"	26.65
	50 x 1.1/2"	27.78
	63 x 1.1/2"	36.29
63 x 2"	36.29	



PLASSON ELECTROFUSION FITTINGS

	PE Cast Iron Flange Trans Coupler 49770:		
	63 x 50	199.99	
	90 x 80	234.98	
	110 x 100	285.03	
	125 x 100	315.02	
	160 x 150	550.00	
	180 x 150	634.97	
	225 x 200	852.39	
		Flange Adaptor 49027:	
		20	6.27
25		6.45	
32		7.51	
40		9.01	
50		11.57	
63		13.43	
75		17.05	
90		22.35	
110		27.91	
125		34.45	
140		44.17	
160		49.38	
180		77.73	
200		88.78	
225		95.49	
250	146.72		
280	193.80		
315	246.10		
355	425.68		
400	750.83		
	Plastic Coated Backing Ring 0990:		
	32 x 1"	18.42	
	40 x 1.1/4"	21.74	
	50 x 1.1/2"	26.80	
	63 x 2"	33.09	
	75 x 2.1/2"	37.63	
	90 x 3"	45.32	
	110 x 4"	61.98	
	125 x 4"	61.98	
	140 x 5"	77.26	
	160 x 6"	95.68	
	180 x 6"	95.68	
	200 x 8"	138.46	
	225 x 8"	137.67	
	250 x 10"	167.01	
	280 x 10"	167.01	
315 x 12"	253.87		
	PE Cast Iron Spigot Trans Coupler 49570:		
	90 x 80	159.94	
	110 x 100	187.13	
	125 x 100	214.18	
	160 x 150	422.99	
	180 x 150	485.32	
	225 x 200	621.08	
	Plated Flange Backing Ring 49029:		
	32x1, 40x1.1/4, 50x1.1/2	17.50	
	63 x 2", 75x2.1/2	17.46	
	90 x 3"	25.93	
	110 x 4"	27.33	
	125 x 4"	27.33	
	140 x 5"	45.05	
	160 x 6"	46.62	
	180 x 6"	46.62	
	200 x 8"	82.76	
	225 x 8"	82.76	
	250 x 10"	131.65	
	280 x 10"	164.48	
	315 x 12"	214.15	
	355 x 14"	297.26	
	400 x 16"	385.96	

PLASSON ELECTROFUSION FITTINGS

	IBC Flange Gasket 7228:	
	1.1/2"	1.18
	2"	1.35
	2.1/2"	1.59
	3"	1.76
	4"	2.13
	5"	2.44
	6"	2.36
	PE Ball Valve 43625:	
	25	168.00
	32	168.00
	40	193.85
	50	232.62
	63	245.54
	75	258.46
	90	452.31
	110	516.93
	125	581.54
	Replacement Valve Spigot 1149:	
	20	4.60
	25	4.66
	32	5.04
	40	6.17
	50	7.50
	63	9.45
	Double Spigot Valve 1148:	
	20	30.17
	25	32.44
	32	37.16
	40	47.43
	50	57.63
	Single Spigot Compression Valve 1378:	
	20	22.80
	25	24.63
	32	28.72
	40	38.93
	50	48.50
	63	42.75





Mechanical Compression Fittings

Plasson Mechanical Compression PP fittings offer solutions for connecting PE pipes, used for conveying water and other fluids in urban and inter-urban infrastructure, industrial, mining, landscape and farming applications and for carrying communication lines.

Plasson Mechanical Compression Fittings are designed to withstand working pressures of up to 16bar, and also include valves which allow the regulation of flow. These fittings are manufactured in diameters ranging from 16mm to 160mm. Plasson compression fittings are available as dedicated Black2Blue metric / imperial fittings as well as there being a range of adaptors for adapting the metric fitting to accept these pipe types. The Plass4 universal pipe fitting allows connections to all approved pipe types of all pipe materials within the tolerance of the fitting











PLASSON MECH FITTINGS	
	7010 Coupling:
	16mm 2.56
	20 3.20
	25 3.43
	32 8.04
	40 17.06
	50 17.77
	63 28.97
	75 44.10
	90 50.87
110 88.68	
125 190.94	
	7110 Reducing Couplings:
	20x16 5.86
	25x16 6.43
	25x20 6.43
	32x20 10.88
	32x25 10.88
	40x25 18.43
	40x32 18.43
	50x25 21.59
	50x32 24.68
	50x40 24.68
	63x25 26.36
	63x32 31.24
	63x40 31.24
	63x50 31.24
	75x50 41.02
	75x63 41.02
90x63 54.52	
90x75 54.52	
110x90 93.75	
	Repair Slip Coupling 7610:
	20 3.85
	25 4.63
	32 10.44
	40 18.85
	50 21.33
63 29.77	
125 201.97	





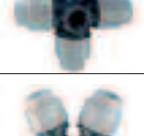

PLASSON MECH FITTINGS	
	Male Adaptor BSP Thread 7020:
	16x3/8 2.12
	16x1/2 2.12
	16x3/4 2.12
	20x1/2 2.99
	20x3/4 3.20
	20x1 4.46
	25x1/2 3.59
	25x3/4 3.59
	25x1 5.55
	32x3/4 5.55
	32x1 5.55
	32x1 5.55
	32x1.1/4 5.55
	32x1.1/2 5.55
	40x1 10.63
	40x1.1/4 10.63
	40x1.1/2 10.63
	40x2 10.63
	50x1 13.58
	50x1.1/4 13.58
	50x1.1/2 13.58
	50x2 13.58
	63x1.1/4 18.20
	63x1.1/2 18.20
	63x2 18.20
	63x2.1/2 18.20
	75x2 27.59
	75x3 27.59
	90x2 37.40
90x2.1/2 37.40	
90x3 37.40	
90x4 37.40	
110x2 63.36	
110x3 63.36	
110x4 63.36	
	Female Adaptor BSP Thread 7030
	16x1/2 2.56
	16x3/4 2.56
	20x1/2 3.59
	20x3/4 3.59
	20x1 3.59
	25x3/4 3.93
	25x1 3.93
	32x3/4 5.28
	32x1 5.28
	32x1.1/4 5.28
	40x1 12.25
	40x1.1/4 12.25
	40x1.1/2 12.25
	50x1.1/4 16.71
	50x1.1/2 16.71
	50x2 16.71
	63x2 21.00
	75x2 28.20
	75x2.1/2 28.20
90x2 38.60	
90x3 38.60	
90x4 38.60	
110x3 81.05	
110x4 81.05	
	Female Adaptor Parallel Thread 7060
	25x3/4 5.29
	25x1 5.29
	32x1 7.05











PLASSON MECH FITTINGS	
	7040 90° Tee:
	16 4.47
	20 5.61
	25 8.77
	32 11.81
	40 22.89
	50 25.43
	63 38.05
	75 68.37
	90 96.52
	110 196.08
	7340 Reducing Tee:
	20x16x20 7.32
	25x20x25 10.66
	32x25x32 15.58
	40x32x40 25.62
	50x25x50 37.19
	50x32x50 37.19
	50x40x50 37.19
	63x32x63 44.84
	63x40x63 44.84
	63x50x63 44.84
75x63x75 76.81	
	7045 Slip Tee:
	20 7.11
	25 10.01
	32 13.64
	40 27.99
	50 31.33
	63 44.34
	7640 45° Tee:
	63 44.34
	75 78.93
	90 142.57
	110 226.57









PLASSON MECH FITTINGS		
	7810 Coupling with riser BSP Thread	
	40x3/4x40 12.78	
	50x3/4x50 17.30	
	50x1x50 17.30	
	63x3/4x63 28.15	
	63x1x63 28.15	
	75x3/4x75 39.42	
	75x1x75 39.42	
		7740 90° Enlarging Tee:
		25x32x25 17.36
	7050 90° Elbow	
	16 2.89	
	20 3.97	
	25 5.84	
	32 9.59	
	40 19.01	
	50 20.32	
	63 26.96	
	75 76.81	
	90 98.13	
110 160.87		
	7150 90° Elbow with threaded Female offtake	
	16x1/2 2.97	
	20x1/2 3.94	
	20x3/4 3.94	
	25x1/2 5.15	
	25x3/4 5.15	
	25x1 5.15	
	32x3/4 8.32	
	32x1 8.32	
	32x1.1/4 8.32	
	40x1 16.75	
	40x1.1/4 16.75	
	40x1.1/2 16.75	
	40x2 16.75	
	50x1 18.75	
	50x1.1/4 18.75	
	50x1.1/2 18.75	
50x2 18.75		
63x1.1/4 23.53		
63x1.1/2 23.53		
63x2 23.53		
75x2 44.86		
75x2.1/2 44.86		
75x3 44.86		
	7850 90° Elbow with threaded Male offtake	
	20x1/2 2.90	
	20x3/4 2.90	
	25x1/2 3.36	
	25x3/4 3.36	
	25x1 3.36	
	32x1 5.67	
	40x1 9.65	
	40x1.1/4 9.65	
	40x1.1/2 9.65	
	50x1 13.26	
	50x1.1/4 13.26	
	50x1.1/2 13.26	
	63x1.1/4 16.29	
	63x1.1/2 16.29	
	63x2 16.29	
	75x2.1/2 27.96	
75x3 27.96		
90x3 47.25		
110x4 60.66		

PLASSON MECHANICAL









PLASSON MECH FITTINGS	
	7510 Reducing Elbow 25x20 6.73
	7129 Blanking Plug 20 1.59 25 1.73 32 1.83 40 2.24 50 3.62 63 3.95
	7350 Spigot Elbow 50 x 40 15.05 50 x 50 15.63 63 x 40 19.33 63 x 50 20.11
	7460 45° Elbow 32 11.22 40 12.77 50 15.90 63 24.73 90 117.05 110 179.98
	7120 End Plug 20 3.95 25 5.06 32 7.36 40 11.46 50 15.29 63 25.62 75 33.22 90 45.13 110 53.74
	7540 Cross with threaded Female offtake 20 x 3/4 8.56
	7550 Y-Fitting with threaded Male offtake 16 x 16 x 3/4 4.47 20 x 16 x 3/4 4.55 20 x 20 x 3/4 5.73 25 x 25 x 3/4 8.56
	7940 Modular Adaptor 20 4.38 25 4.79 32 8.67 40 12.26 50 19.31 63 28.05
	7450 45° Elbow with threaded male offtake 20 x 1/2 2.65 20 x 3/4 2.65
	7930 Reducing Set 25 x 20 2.31 32 x 20 3.36 32 x 25 3.36 40 x 32 4.70 50 x 25 6.85 50 x 32 6.67 50 x 40 7.14 63 x 25 9.98 63 x 32 9.98 63 x 50 9.98 75 x 63 24.87 110 x 63 40.41 110 x 75 38.20 110 x 90 32.30

PLASSON MECH FITTINGS	
	7250 Threaded Adaptor BSP Offtake 25x1/2 5.20 25x3/4 5.20 32x1/2 5.55 32x3/4 5.55 32x1 5.55 40x1 6.78 40x1.1/4 6.78 40x1.1/2 6.78 50x1 9.85 50x1.1/4 9.85 50x1.1/2 9.85 50x2 9.85 63x1 14.32 63x1.1/4 14.32 63x1.1/2 14.32 63x2 14.32 63x2.1/2 14.32 75x1.1/2 22.06 75x2 22.06 75x2.1/2 22.06 75x3 22.06
	7236 Spigot Flange Adaptor NP16/10 with metal blacking ring 50x1.1/2 26.96 50x2 26.96 63x2 31.97 75x2 38.03 75x2.1/2 38.03 75x3 38.03 90x2.1/2 48.26 90x3 48.26 90x4 48.26 110x3 72.39 110x4 72.39 110x5 81.63
	7220 Compression Flange Adaptor NP16/10 with metal backing ring 50x1.1/2 34.10 50x2 34.10 63x2 52.70 75x2.1/2 61.50 90x3 72.39 90x4 72.39 110x4 90.50 125x5 138.77 125x6 138.77
	7228 IBC Flange Gaskets 1.1/2 1.24 2 1.42 2.1/2 1.67 3 1.85 4 2.24 5 2.56 6 2.76
	77017 Plass4 Universal Coupling 15-22 25 11.76 20-27 25 12.56 20-27 32 16.58 27-35 25 16.58 27-35 32 19.43 35-50 50 35.88
	77057 Plass4 Universal Elbow 15-22 25 12.08 20-27 25 13.11 27-35 25 21.09

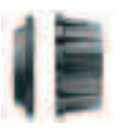

PLASSON MECH FITTINGS	
	7436 Dedicated PE to Copper 15x20 5.57 15x25 5.78 22x25 5.92 28x32 11.11
	7950 Pipe Liner 20 0.28 25 0.30 32 0.46 40 0.68 50 0.85 63 1.04
	7478 Metric to Imperial Elbow 20x1/2 4.70 25x1/2 8.03 25x3/4 6.76 32x1 11.27 50x1.1/2 22.29 63x2 30.67
	7454 Imperial to Imperial Elbow 1/2x1/2 7.54 3/4x1/2 8.81 3/4x3/4 10.02 1.1/4x1.1/4 19.74 1.1/2x1.1/2 25.80 2 x 2 33.83
	7428 Imperial Adaptor to Male BSP Thread 1/2 x 1/2 3.58 3/4x1/2 3.58 3/4x3/4 4.65 1.1/2x1.1/2 15.259 2 x 2 20.91
	7418 Metric to Imperial Slip Coupling 20x3/8 6.56 20x1/2 3.50 25x3/8 6.93 25x1/2 5.30 25x3/4 3.98 32x1 8.51 32x1.1/4 17.44 50x1.1/4 22.42 50x1.1/2 22.42 63x2 31.38
	3489 Imperial in-line Valve 1/2 19.78 3/4 23.61
	7388 Imperial Adaptor to Female BSP Thread 1/2 4.42 3/4 4.73 1 6.24 1.1/2 17.24 2 24.06
	7494 Imperial Elbow to Male BSP Thread 1/2x1/2 5.05 1/2x3/4 5.36 3/4x1/2 6.08 3/4x3/4 6.32
	7474 Imperial Elbow to Female BSP Thread 1/2x1/2 5.79 1/2x1/4 6.24 3/4x3/4 7.39

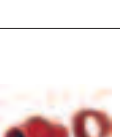
PLASSON MECH FITTINGS	
	7444 Imperial Tee 1/2x1/2x1/2 11.29 3/4x1/2x3/4 12.79 3/4x3/4x3/4 11.55 1.1/4x1.1/4 32.78 1.1/4x1.1/4x1.1/4 20.65 1.1/2x1.1/4x1.1/2 46.24 1.1/2x1.1/2x1.1/2 27.22 2x1.1/2x2 54.29 2x2x2 42.38
	7144 Imperial Tee with Female BSP Offtake 1/2x3/4x1/2 8.61 3/4x3/4x3/4 12.13 1 x 1 x 1 15.32 1.1/4x1.1/4x1.1/4 21.35 1.1/2x1.1/2x1.1/2 29.46 2 x 2 x 2 36.81
	7404 Imperial to Imperial Coupling 1/2x1/2 6.64 3/4x3/4 9.12
	7415 PlasShield Elbow 25x25 6.08 27.4x27.4 7.04 32x32 9.21 34.5x34.5 10.30 63x63 29.40 65.8x65.8 29.40
	7416 PlasShield Coupler 25x25 6.08 27.4x27.4 7.04 32x32 9.21 34.5x34.5 10.30 63x63 29.40 65.8x65.8 29.40
	7414 PlasShield Male Adaptor 25x3/4 4.10 27.4x3/4 4.22 32x1 5.44 34.5x1 6.08 63 21.34 65.8 21.34
	7413 PlasShield Tee 63x63 41.24 65.8x65.8 44.37
	7417 PlasShield x Copper Kit 15x25 6.71 15x27.4 6.71 22x25 6.59 22x27.4 6.59 28x32 10.48 28x34.5 10.99
	7400 PlasShield Adaptor Kit to adapt Standard Fittings 25 (Puriton) 1.33 27.4 (Protectaline/Trigon) 2.00 32 (Puriton) 1.84 34.5 (Protectaline/Trigon) 2.82 63 (Puriton) 4.26 65.8 (Protectaline) 4.26
	Protective Tapes for use with PlasShield 6101 Aluminium 50mm x 45m 18.80 6102 Waterproof 50mmx15 12.22 6103 Petrolatum 50mm x 10m (Denso) 8.39











PLASSON MECH FITTINGS

	7785 Damaged Metric Pipe Adaptor 20 0.61 25 0.74 32 0.88 63 1.15
	7438 Copper Adaptor for Table X and Y 20-15 3.15 25-15 4.07 25-22 3.85 32-28 5.77 40-35 7.11 50-42 9.73 63-54 10.88
	7896 Universal Adaptor Galv & PVC 20-15 2.12 25-22(or 1/2) 2.50 32-28 (or 3/4) 2.76 40-35 (or 1) 9.16 50-42 (or 1.1/4) 9.93 50 - 1.1/2 14.71 63 - 2 16.21
	7782 Lead Adaptor 25- 3/8 5LB 1.76 25-1/2 7LB 1.46 32-1/2 9LB 2.10 32-3/4 9LB 1.77 40-3/4 11LB 3.45 50-1 16LB 4.28
	7970 Metric PVC Adaptor 20 1.44 25 1.60 32 1.76 40 2.26 50 3.38 63 3.86
	7786 Low Density Class C BS 1972 Adaptor (Light Blue) 20-3/8 0.92 20-1/2 0.59 25-3/4 0.70 32-1 0.84 50-1.1/4 1.95 50-1.1/2 2.46 63-2 3.84
	7788 High Density Class C Adaptor BS3284 (Dark Blue) 20-1/2 0.58 25-3/4 0.70 32-1 0.84 50-1.1/4 1.95 50-1.1/2 2.45 63-2 3.78
	7995 Normal Gauge Adapter IRS 134:1977 (Red) 20-1/2 0.58 25-3/4 0.70 32-1 0.84 50-1.1/4 1.95 50-1.1/2 2.45 63-2 3.78
	7787 Low Density Class D Adaptor BS1972 (Light Green) 20-1/2 0.58 25-3/4 0.70 32-1 0.84 50-1.1/4 1.95 50-1.1/2 2.45



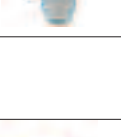



PLASSON MECH FITTINGS

	7789 High Density Class D Adaptor BS3284 (Dark Green) 20-3/8 0.92 20-1/2 0.59 25-3/4 0.70 32-1 0.84 50-1.1/4 1.95 50-1.1/2 2.46 63-2 3.84
	7996 Heavy Gauge Adaptor IRS 134:1977 (Pale Blue) 20-1/2 0.58 25-3/4 0.70 32-1 0.84 50-1.1/4 1.95 50-1.1/2 2.45











PLASSON MECH VALVES

	9051 Below Ground Gun Metal Stoptap BS5433 Square Head 20 35.10 25 46.80 32 88.44
	9050 Universal Stoptap BS5433/1010 Type 20 30.97 25 39.11 32 81.90
	9048A Below Ground DZR Stoptap Poly xPoly 50mm (Assembly Required) 204.32 63mm Assembly+PTFE Tape Required 220.53
	60124 Water Valve Key 12mm Shaft 27.96 16mm Shaft 30.38
	9055 Wall Plate Elbow 20-1/2 15.48 25-3/4 19.42
	3407 Compression Stoptap Above & Below Ground BS5433 Type 20 18.90 25 26.77 32 41.47
	1379 Compression Ball Valve (PVC) 20-1/2 15.57 25-3/4 17.87 32-1 20.74 50-1.1/4 29.06 50-1.1/2 39.56 63-2 70.20
	3405 BSP Stoptap for Above Ground BS1010/2 Type 3/4 8.12 1 8.75
	7750 Wall Plate Elbow (Plastic) 20 x 1/2 8.01 25 x 3/4 10.69
	7012 25mm Check Valve Kit 20.25
	9057 DZR Double Check Valve Female to BS 6282/5 3/4 37.93 1" 41.65

PLASSON MECH THREADED

	5017 Threaded Socket 1/2 1.57 3/4 2.31 1 2.89 1.1/4 3.15 1.1/2 3.67 2 8.23 3 16.41
	5027 Threaded Reducing Bush 1/2x3/8 1.51 3/4x3/8 1.54 3/4x1/2 1.48 1 x 1/2 1.60 1 x 3/4 1.60 1.1/4x1/2 2.08 1.1/4x3/4 2.08 1.1/4x1 2.08 1.1/2x1/2 2.53 1.1/2x3/4 2.53 1.1/2x1 2.53 1.1/2x1.1/4 2.53 2 x 1/2 3.92 2 x 1/4 3.92 2 x 1 3.92 2 x 1.1/4 3.92 2 x 1.1/2 3.92 2.1/2x 2 5.27 3 x 1 8.57 3 x 1.1/4 8.57 3 x 1.1/2 8.57 3 x 2 8.57 3 x 2.1/2 8.57 4 x 2 8.65 4 x 3 8.65
	5047 90° Threaded Tee 1/2 2.31 3/4 2.60 1 3.86 1.1/4 5.61 1.1/2 6.61 2 7.21
	5157 90° Threaded Elbow Male/Female 1/2 2.00 3/4 2.48 1 3.06
	5057 90° Threaded Elbow 1/2 1.81 3/4 2.39 1 2.99 1.1/4 4.13 1.1/2 4.74 2 5.98
	5067 Threaded Nipple 1/2x1/2 1.32 3/4x3/4 1.48 1 x 1 1.74 1.1/4x1.1/4 2.66 1.1/2x1.1/2 3.49 2 x 2 5.15 3 x 3 13.67
	5065 Threaded Reducing Nipple 3/4 x 1/2 1.48 1 x 1/2 1.74 1 x 3/4 1.74 1.1/4x1/2 2.66 1.1/4x3/4 2.66 1.1/4 x 1 2.66 1.1/2x1/2 3.49 1.1/2x3/4 3.49 1.1/2x1 3.49 1.1/2x1.1/4 3.49 2 x 1/2 5.15 2 x 3/4 5.15 2 x 1 5.15 2 x 1.1/4 5.15 2 x 1.1/2 5.15

PLASSON MECH THREADED

	5177 Threaded Plug 3/8 1.04 1/2 1.17 3/4 1.17 1 1.61 1.1/4 1.89 1.1/2 2.88 2 4.54
	5117 Threaded Reducing Socket 3/4 x 1/2 1.89
	6000 PTFE Tape Per Roll 0.83
PLASSON MECH ACCESSORIES	
	7960 Chamfer Tool 20/32 57.43
	60125 Pipe Shears 30.08
	7990 Plasson Wrench 16/40 5.44 40/75 34.20 63/125 47.25
	7992 Universal Strap Wrench 20-90mm 28.48
	60123 Pipe Squeeze off Tool 20/32 41.33
	60123A Pipe Squeeze off Tool 32/63 69.39
	60120 MDPE Pipe Clips (Connectable) 20mm 0.34 25mm 0.37 32mm 0.42 50mm 0.76 63mm 0.84